

# OPERATING, INSTALLATION AND SERVICE MANUAL STORAGE TYPE GAS WATER HEATER

95001 12/94



**WARNING:** This information in these instructions must be followed exactly. Improper installation, adjustment, alteration, service or maintenance can cause property damage, personal injury or death.

**DO NOT STORE OR USE GASOLINE OR OTHER COMBUSTIBLE MATERIALS OR LIQUIDS NEAR OR ADJACENT TO THIS HEATER OR ANY OTHER APPLIANCE.**

## WHAT TO DO IF YOU SMELL GAS

1. Do not try to light any appliance.
2. Do not touch any electric switch.
3. Do not use any phone in your building.
4. Immediately call your gas supplier from a neighbor's phone following the gas supplier's instructions.
5. If you cannot reach your gas supplier, call the fire department.

**THIS APPLIANCE SHALL NOT BE INSTALLED IN ANY LOCATION WHERE FLAMMABLE LIQUIDS OR VAPORS ARE LIKELY TO BE PRESENT. FLAMMABLE VAPORS MAY BE DRAWN TO THIS WATER HEATER FROM OTHER AREAS OF THE STRUCTURE BY AIR CURRENTS.**

Installation and service must be performed by a qualified installer, service agency or the gas supplier.

THIS WATER HEATER SHALL NOT BE INSTALLED IN BATHROOMS, BEDROOMS, OR ANY OCCUPIED ROOM NORMALLY KEPT CLOSED.

## **▲ WARNING ▲**

This water heater is equipped for one type gas only. Check the data plate near the gas control valve for the correct gas. **DO NOT USE THIS WATER HEATER WITH ANY GAS OTHER THEN THE ONE LISTED ON THE DATA PLATE.** Failure to use the correct gas can cause problems which can result in **DEATH, SERIOUS BODILY INJURY OR PROPERTY DAMAGE.** If you have any questions or doubts consult your gas supplier or gas company. Water heaters for bottled, propane or liquefied petroleum gas (LPG) are different from natural gas models. A natural gas heater will not function safely on bottled, propane or liquefied petroleum gas (LPG) and no attempt should be made to convert a heater from natural gas to any other gas.

**INSTALLER:**

1. AFFIX THESE INSTRUCTIONS TO OR ADJACENT TO WATER HEATER.
2. BEFORE LEAVING PREMISES: **REVIEW** THIS OPERATION AND SERVICE MANUAL TO BE SURE HEATER HAS BEEN INSTALLED CORRECTLY. MAKE SURE UNIT IS STARTED AND OPERATED FOR ONE COMPLETE CYCLE AND WATER TEMPERATURE IS ACCEPTABLE TO THE CONSUMER AT THE FIXTURES.

**OWNER:**

1. RETAIN THESE INSTRUCTIONS AND WARRANTY FOR FUTURE REFERENCE.

ALL TECHNICAL AND WARRANTY QUESTIONS SHOULD BE DIRECTED TO THE LOCAL DEALER FROM WHOM THE WATER HEATER WAS PURCHASED. IF YOU ARE UNSUCCESSFUL PLEASE WRITE TO THE COMPANY LISTED ON THE WARRANTY OR DATA PLATE WHICH CAME WITH YOUR WATER HEATER.

**CALL THIS TOLL FREE NUMBER 1-800-900-9063 WITH ANY QUESTIONS DURING OR AFTER INSTALLATION.**

# ! DANGER

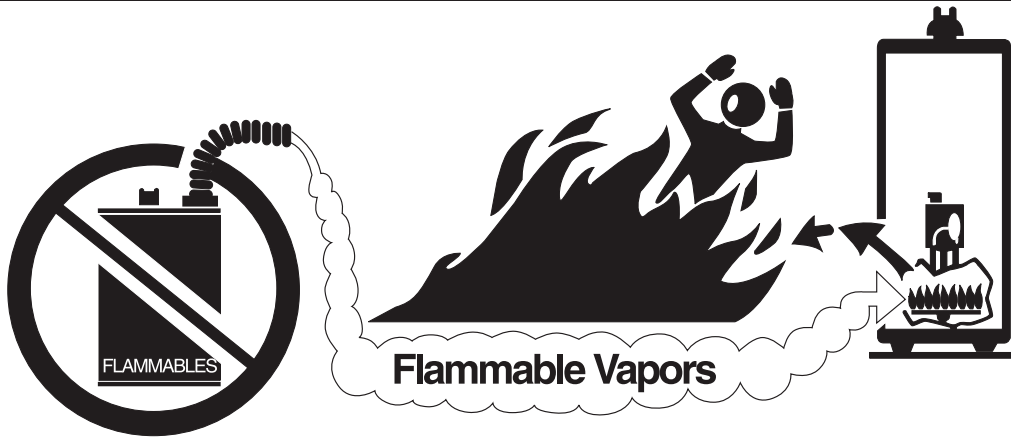

**! Vapors from flammable liquids will explode and catch fire causing death or severe burns.**

Do not use or store flammable products such as gasoline solvents or adhesives in the same room or area near the water heater.

Keep flammable products:

1. far away from heater,
2. in approved containers,
3. tightly closed and
4. out of children's reach.

Water heater has a main burner and pilot flame. The pilot flame:

1. is on all the time and
2. will ignite flammable vapors

Vapors:

1. cannot be seen,
2. are heavier than air,
3. go a long way on the floor and
4. can be carried from other rooms to the pilot flame by air currents.

Installation:

Do not install water heater where flammable products will be stored or used such as a garage, basement, storage area or utility room unless the main burner and

pilot flames are at least 18" above the floor. This will reduce, but not eliminate, the risk of vapors being ignited by the main burner or pilot flame.

Read and follow water heater warnings and instructions.

If owners manual is missing, contact the retailer or manufacturer.

# ! DANGER

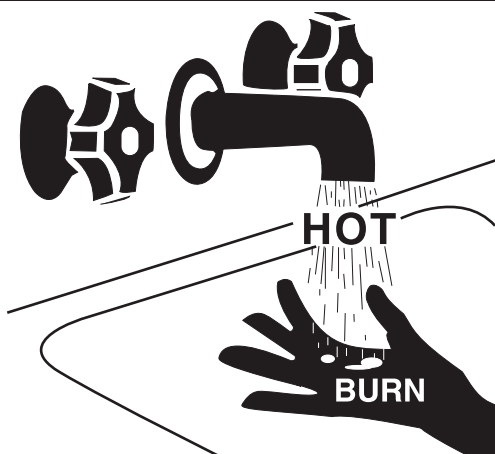

Water temperature over 125° F can cause severe burns instantly or death from scalds.

Children, disabled and elderly are at highest risk of being scalded.

See instruction manual before setting temperature at water heater.

Feel water before bathing or showering.

Temperature limiting valves are available, see manual.

1-89

A 6600874

A  
PAGE

# TABLE OF CONTENTS

	PAGE
DANGER .....	A
TABLE OF CONTENTS, INSTALLATION INFORMATION .....	B
CONSUMER RESPONSIBILITIES, PRESSURE BUILD-UP .....	1
LOCATION, CLEARANCES FROM COMBUSTIBLE CONSTRUCTION, DISCHARGE OF PURGED GASES .....	2
AIR SUPPLY, ALL AIR FROM INSIDE THE BUILDING, ALL AIR FROM OUTSIDE THE BUILDING .....	3
TYPICAL INSTALLATION .....	4
MECHANICAL EXHAUSTING AND FIREPLACES, VENTING, GAS PIPING INSTALLATION, INSTALLATION SAFETY WARNING - L.P. UNITS, TEMPERATURE AND PRESSURE RELIEF VALVE .....	5
COMBINATION SPACE HEATING/POTABLE WATER HEATING, WATER PIPING .....	6
SOLAR INSTALLATION, CHEMICAL VAPOR CORROSION, INSULATION BLANKET, INSTALLATION CHECK LIST .....	7
OPERATION, SAFETY PRECAUTIONS, CONDENSATION, NATURAL GAS MODELS, L.P. MODELS, OUT OF FUEL, HYDROGEN GAS WARNING, EXPOSURE TO WATER .....	8
SAFETY INSTRUCTIONS, LIGHTING INSTRUCTIONS .....	9, 10
TEMPERATURE ADJUSTMENT, BURNER ADJUSTMENT, BURNER MAINTENANCE, EMERGENCY SHUT DOWN .....	11
REMOVAL OF BURNER ASSEMBLY, REPLACING BURNER ASSEMBLY, THERMOCOUPLE AND/OR PILOT REPLACEMENT, DRAINING AND FLUSHING INTERIOR OF TANK, VENTING SYSTEM INSPECTION, TAMPERING .....	12
ANODE, WATER HEATER SOUNDS, QUALIFIED SERVICE PERSONS, COMMON COMPLAINTS TO CHECK BEFORE CALLING FOR SERVICE .....	13
COMMON COMPLAINTS CONTINUED .....	14, 15
REPAIR PARTS ILLUSTRATION .....	16

**WARNING: IMPROPER INSTALLATION, ADJUSTMENT, ALTERATION, SERVICE OR MAINTENANCE CAN CAUSE INJURY, DEATH OR PROPERTY DAMAGE. READ AND REFER TO THIS MANUAL.**

Please complete the following information at the time of installation. This should be retained and presented along with the warranty in the event a claim is necessary.

MODEL NUMBER: \_\_\_\_\_ TYPE: \_\_\_\_\_

SERIAL NUMBER: \_\_\_\_\_

INSTALLATION ADDRESS: \_\_\_\_\_

\_\_\_\_\_

THIS WATER HEATER HAS BEEN INSTALLED IN ACCORDANCE WITH THESE INSTALLATION INSTRUCTIONS AND LOCAL CODE REQUIREMENTS ON \_\_\_\_\_

*Date*

INSTALLER: \_\_\_\_\_

\_\_\_\_\_

\_\_\_\_\_

## CONSUMER RESPONSIBILITIES

THIS MANUAL HAS BEEN PREPARED TO ACQUAINT YOU WITH THE INSTALLATION, OPERATION AND MAINTENANCE OF YOUR GAS WATER HEATER AND TO PROVIDE IMPORTANT SAFETY INFORMATION.

WE URGE YOU TO READ ALL INSTRUCTIONS THOROUGHLY before attempting installation or operation of your water heater. Keep these instructions for future reference.

The manufacturer of this water heater will not be liable for any damages caused by failure to comply with the installation and operating instructions outlined on the following pages. These instructions are a guide for the correct installation of your water heater. If you lack the necessary skills required or have difficulty following the directions, you should not proceed but get help from a qualified person for that part of the installation you do not understand. Your gas-fired water heater is design-certified by the American Gas Association Laboratories. The installation should conform with the local code or the authority having jurisdiction, or in the absence of such, the National Gas Code. ANSI Z223.1 (NFPA 54) 1992. A copy of the 1992 edition of the Code can be purchased from A.G.A. Order Processing, 1515 Wilson Boulevard, Arlington, VA 22209 (703) 841-8559. A rating plate identifying your water heater will be found next to the gas control valve (thermostat).

When referring to your water heater always have the information listed on the rating plate readily available.

## PRESSURE BUILD-UP IN CLOSED WATER SYSTEMS

The water utility supply meter may contain a check valve, back flow preventer or water pressure reducing valve. This will create a closed water system. During the heating cycle of the water heater, the water expands creating a pressure build-up in the water system. A temperature and pressure relief valve must be installed on the water heater (150 PSI maximum pressure setting. See Temperature and Pressure Relief Valve). To prevent the temperature and pressure relief valve from discharging hot water, loss of energy, and reduce the possible build-up of lime on the temperature and pressure relief valve seat.

**AN EXPANSION TANK MUST BE INSTALLED** on the cold water supply line. For every 50 U.S. gallons of stored water, the expansion tank must have a minimum capacity of 1.5 U.S. gallons.

If water heater is installed in a closed water system, contact the water supplier or local plumbing inspector on how to control this situation.

## LOCATION

Location selection should be as close to the stack or chimney as practical and as centralized with the piping system as possible. Water heater should be located in an area not subject to freezing temperatures.

The water heater should be located so that the controls and drain are easily accessible (at least 24 inches in front of the water heater). The heater should be located in an area where leakage of the tank or connections will not result in damage to the area adjacent to the water heater or to lower floors of the structure. When such locations cannot be provided, a suitable drain pan must be installed under the heater. Such pans must limit the water level to a maximum depth of 1 3/4 inches inside of pan, have a minimum length and width of at least two inches greater than the diameter of the heater, and must be piped to an adequate drain. The pan must not restrict combustion air flow. (Figure 6)

Under no circumstances is the manufacturer to be held liable for any water damage in connection with this water heater.

### ▲ WARNING ▲

When this heater is installed directly on carpeting, carpeting must be protected by a metal or wood panel beneath the appliance extending beyond the full width and depth of the appliance by at least 3 inches in any direction, or if the appliance is installed in an alcove or closet, the entire floor must be covered by the panel. **FAILURE TO HEED THIS WARNING MAY RESULT IN FIRE HAZARD.**

## CLEARANCES FROM COMBUSTIBLE CONSTRUCTION

	A	B	C	D
75-76	18"	2"	6"	6"
100-83	18"	2"	6"	6"

A minimum of 24 inches front clearance should be provided for inspection and servicing.

## CERTIFIED FOR ALCOVE INSTALLATION

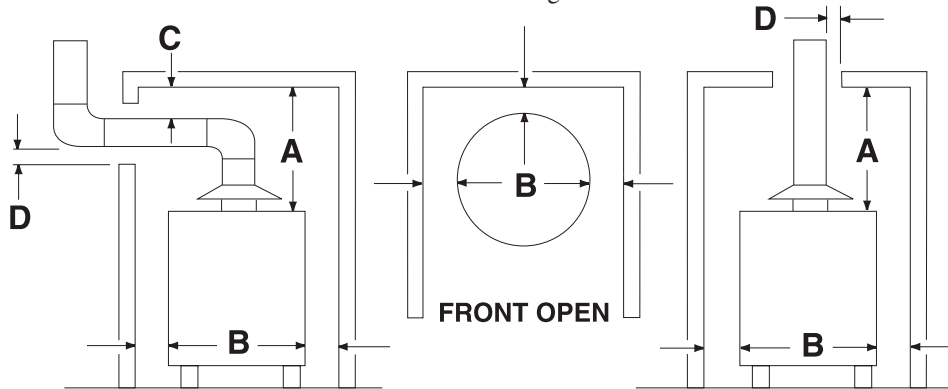

## CERTIFIED FOR INSTALLATION ON COMBUSTIBLE FLOOR

**RESIDENTIAL AREA WHICH MAY NOT BE SUITABLE FOR HEATER INSTALLATION** would include those areas where flammable liquids (such as gasoline, solvents, liquefied propane or butane, etc.) or other substances (such as adhesives, etc.) all of which emit flammable vapors, may be improperly stored or used. Because of natural air movement in a room or other enclosed space, flammable vapors can be carried some distance from where their liquids are being used or stored. The gas water heater pilot flame or main burner can ignite such vapors. The resulting flash-back and tire can cause death or serious burns to anyone in the area, as well as property damage. For these reasons the water heater must not be installed in an area where there may be flammable vapors. If such flammables must be used, all gas burning appliances in the vicinity must be shut off, including their pilot lights, to avoid vapors igniting and open doors and windows for ventilation .

If installation in a garage is your only option, the installation must be accomplished in a way that the pilot flame and main burner flame are elevated from the floor at least 18 inches. While this may reduce BUT NOT eliminate the chances of flammable vapors from a spill being ignited, gasoline or other flammable substances must never be stored or used in the same room or area containing a gas water heater or other open flame or spark-producing appliance.

**REMEMBER:** Flammable vapors may be drawn to this water heater from other areas of the structure by air currents.

**NOTE:** HEATER SHALL BE LOCATED OR PROTECTED SO IT IS NOT SUBJECT TO PHYSICAL DAMAGE BY MOVING VEHICLES OR AREA FLOODING.

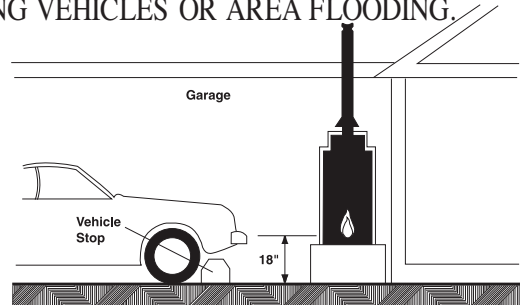

Typical Installation in Residential Garages. (Drawing copyright by the American Gas Association. Used by permission of the copyright holder.)

## DISCHARGE OF PURGED GASES

When removing purged gases from a piping system, care should be taken not to create a hazardous condition, such as discharging the gases into a confined area or in an area which contains an ignition source.

## AIR SUPPLY

Do not install the water heater in small enclosures unless ample ventilation and combustion air is supplied. Sufficient fresh air must be drawn from the outside of the enclosure. Confined areas shall have two permanent openings. See Figures 2 thru 5 for location of openings.

## ALL AIR FROM INSIDE THE BUILDING

The confined space shall be provided with two permanent openings communicating directly with an additional room(s) of sufficient volume so that the combined volume of all spaces meets the criteria for an unconfined space. The total input of all gas utilization equipment installed in the combined space shall be considered in making this determination. Each opening shall have a minimum free area of 1 square inch per 1,000 BTU per hour of the total input rating of all gas utilization equipment in the confined space, but not less than 100 square inches. One opening shall be within 12 inches of the top and one within 12 inches of the bottom of the enclosure. (Figure 2).

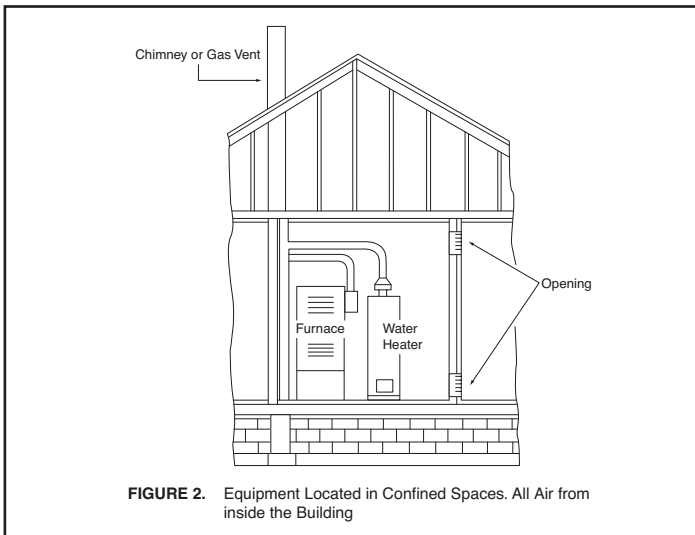

## ALL AIR FROM OUTDOORS

The confined space shall be provided with two permanent openings, one commencing within 12 inches of the top and one commencing within 12 inches of the bottom of the enclosure. The openings shall communicate directly, or by ducts, with the outdoors or spaces (crawl or attic) that freely communicate with the outdoors.

1. When directly communicating with the outdoors, each opening shall have a minimum free area of 1 square inch per 4,000 BTU per hour of total input rating of all equipment in the enclosure. (Figure 3).
2. When communicating with the outdoors through vertical ducts, each opening shall have a minimum free area of 1 square inch per 4,000 BTU per hour of total input rating of all equipment in the enclosure. (Figure 4).
3. When communicating with the outdoors through horizontal ducts, each duct opening shall have a minimum free area of 1 square inch per 2,000 BTU per hour of total input rating of all equipment in the enclosure. (Figure 5).
4. When ducts are used, they shall be of the same cross-sectional area as the free area of the openings to which they connect. The minimum dimension of rectangular air ducts shall not be less than 3 inches. For other combustion and ventilation air openings, refer to the National Fuel Gas Code ANSI Z223.1.

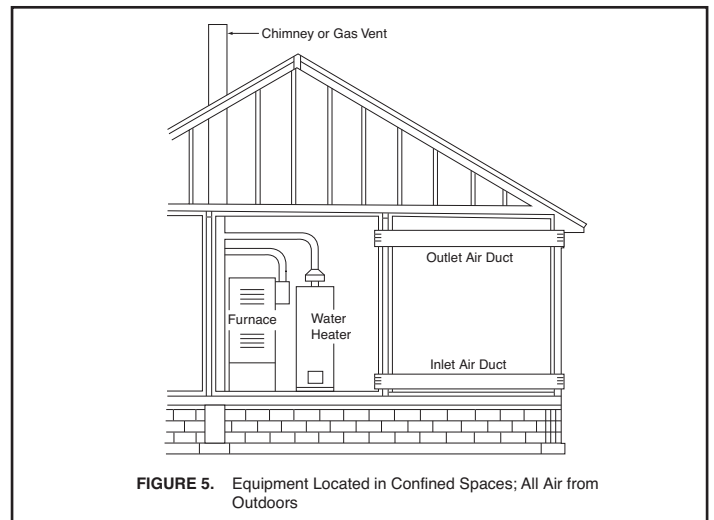
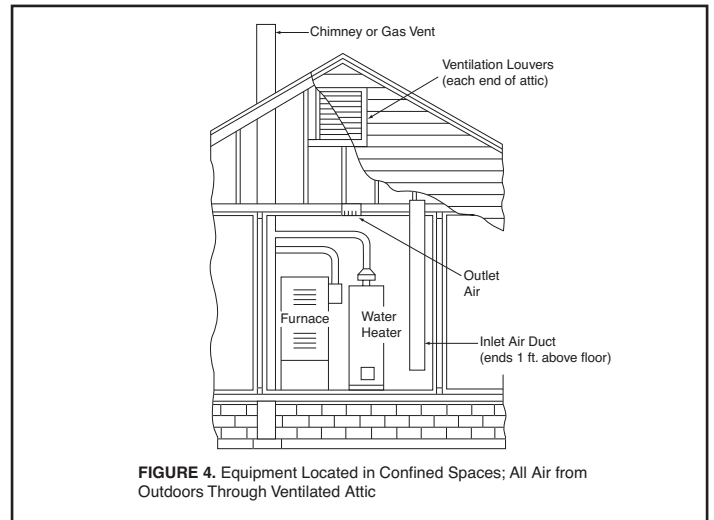
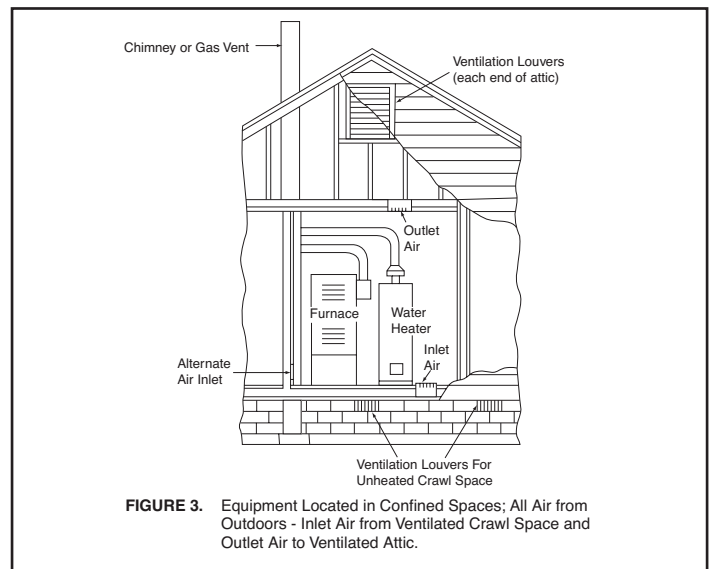

## NOTE:

*\*If the equipment room is located against an outside wall and the air openings communicate directly with the outdoors, each opening shall have a free area of not less than one square inch per 4,000 BTU per hour of the total input rating of all equipment in the enclosure.*

*Illustrations for Figures 2-5 copyright by the American Gas Association.*

*Used by permission of the copyright holder.*

# TYPICAL INSTALATION

**NOTE:**

1. WHEN CONNECTIG MORE THAN ONE APPLIANCE INTO A COMMON CHIMNEY, THE WATER HEATER'S VENT CONNECTOR MUST ENTER THE CHIMNEY ABOVE ALL OTHER VENT CONNECTORS.
2. DO NOT VENT A NATURAL DRAFT APPLIANCE (SUCH AS THIS HEATER) AND A FORCED DRAFT OR POWER VENT APPLIANCE INTO THE SAME CHIMNEY.

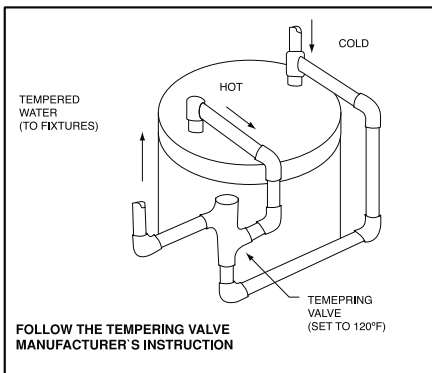
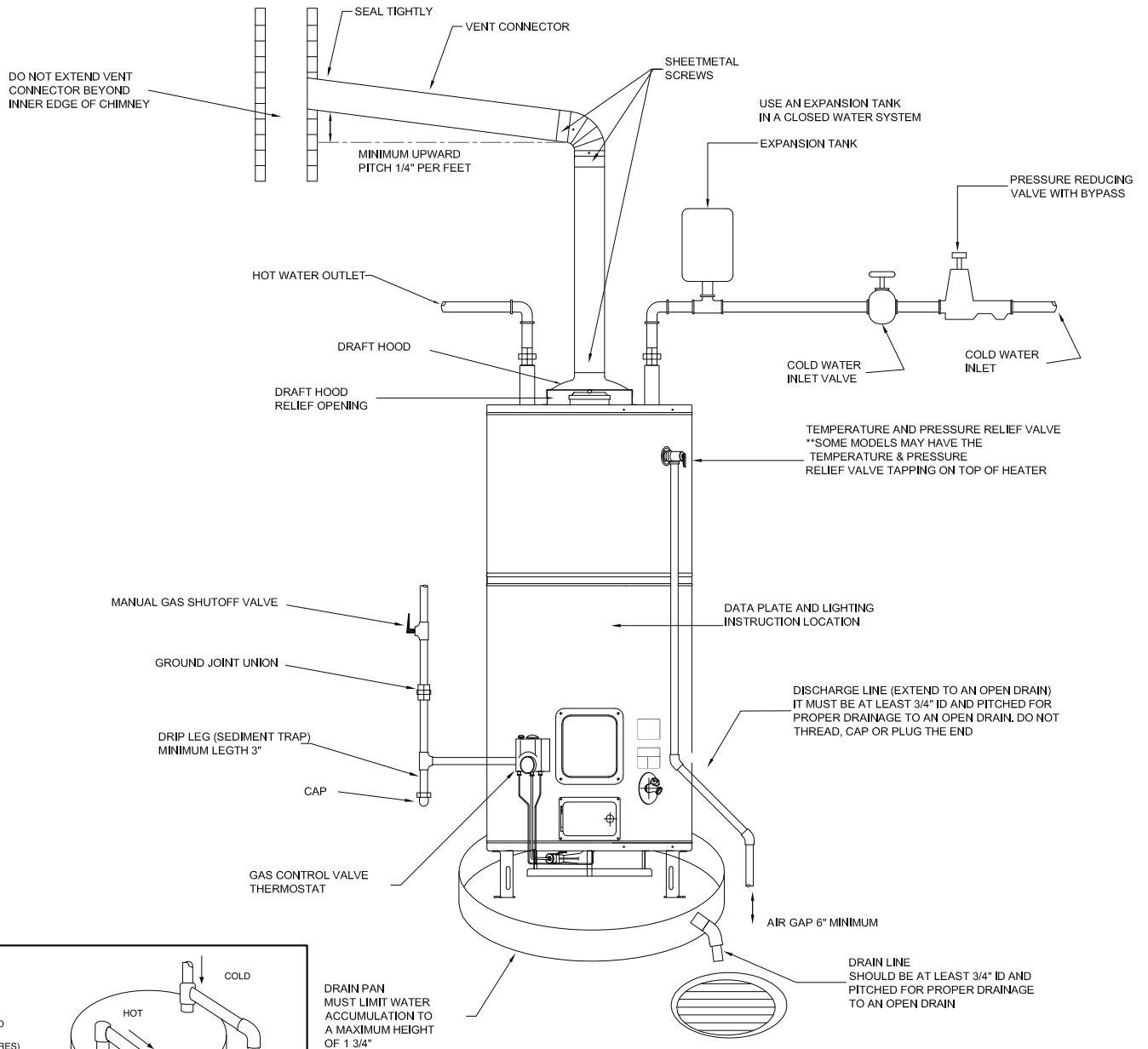
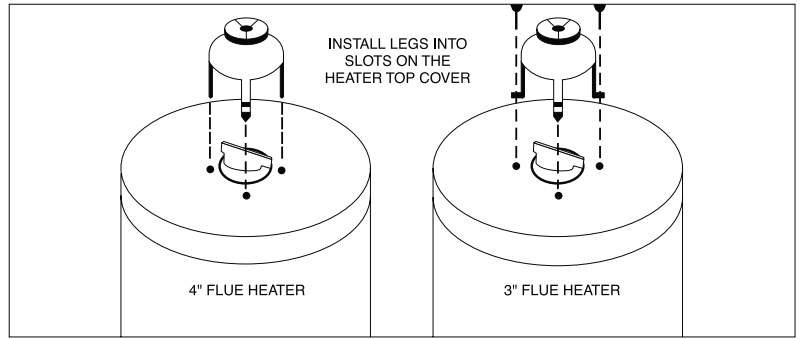

**NOTE: WATER HEATER MUST BE INSTALLED LEVEL**

**FIGURE 6**

## POTENTIAL HAZARDOUS DOWNDRAFT OPERATION

- EXHAUST FANS
- VENTILATION SYSTEMS
- CLOTHES DRYERS
- FIREPLACES
- OTHERS

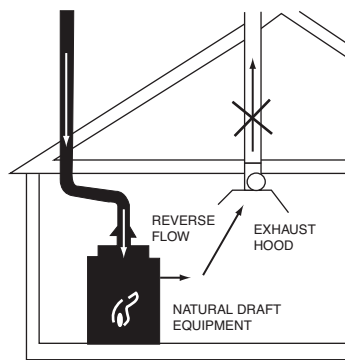

## MECHANICAL EXHAUSTING AND FIREPLACES

The operation of air-moving devices such as exhaust fans, ventilation systems, clothes dryers, fireplaces, etc., can affect the proper operation of gas utilization equipment. Consequently, special attention must be given to conditions these devices may create to avoid unsatisfactory operation of the equipment.

## VENTING

### ▲ WARNING ▲

There are various types of vent dampers currently available. Some of these vent dampers are certified by the American Gas Association Laboratories. The certifications apply to the vent damper device only and does not mean they are certified for use on this water heater. The use of these devices is not permitted by the manufacturer of this water heater.

The water heater must be connected to the chimney. The vent pipe from the heater to the chimney (vent connector) must be no less than the diameter of the draft hood outlet on the heater and should slope upward to the chimney at least 1/4 inch per linear foot. (Figure 6).

Due to great variances in installations, unforeseeable by the manufacturer of the water heater, increased size vent connectors and pipes may be necessary for proper venting. Consult your local utility. They will aid you in determining the proper venting for your heater from the vent tables in the American National Standards Z223.1 (NFPA 54) "National Fuel Gas Code."

**Draft hood:** If you are replacing an old heater be sure to use the new draft hood supplied with the new heater. Secure draft hood in place with screw provided.

## GAS PIPING INSTALLATION

All piping must comply with local and state ordinances or with the National Fuel Gas code ANSI Z223.1 (NFPA 54), whichever applies.

Use clean black iron pipe or equivalent material approved by local codes and ordinances for gas piping. Install a ground-joint-union in the supply line as close to the water heater as possible. A manual gas shut-off valve should be at least 5 feet above floor level and readily accessible. A drip leg (consisting of a pipe tee, 4 inch nipple, and a cap) should be installed as shown in Figure 6.

Make sure the gas supplied to the heater is the same type as listed on the rating plate. **DO NOT ATTEMPT TO USE THIS WATER HEATER WITH ANY GAS OTHER THAN THE TYPE LISTED ON THE RATING PLATE.**

Compound used for the connection of all gas piping should be resistant to the action of liquefied petroleum (L.P.) gases. Apply pipe dope sparingly to the male threads only. **DO NOT** apply pipe dope to

the gas valve inlet. Make certain that no pipe dope has become lodged in the inlet screen of the gas valve. This will restrict the flow of gas. When attachment of gas piping to gas valve inlet is made, extreme care must be taken to prevent pipe dope from entering the gas valve inlet and to avoid excessive torque to prevent cracking of the gas valve inlet housing. The suggested maximum torque is 31.5 ft. lbs. The manufacturer of this water heater will not be liable for any damage or injury caused as a result of a cracked gas inlet from excessive torque.

After completing all gas connections, check each gas connection and fitting for leaks. Use a soap and water solution or a commercial leak detector fluid. **NEVER USE MATCHES OR OPEN FLAME WHEN CHECKING FOR GAS LEAKS.**

The water heater and its individual gas shut off valve must be disconnected from the gas supply piping system during any pressure testing of that system at test pressures in excess of 1/2 psig (14" W.C.) or 3.5 kPa.

The water heater must be isolated from the gas supply piping system by closing its individual manual shut-off valve during any pressure testing of the gas supply piping system at test pressures equal to or less than 1/2 psig (14" W.C.) or 3.5 kPa.

If the gas valve is subjected to pressure exceeding 1/2 psig, the damage to the gas valve could result in an extremely hazardous condition. If this has occurred, the gas valve must be replaced contact your dealer for service. It is recommended that all service work be done by qualified service agency.

## INSTALLATION SAFETY WARNING

**L.P. UNITS:** Liquefied petroleum (L.P.) gas is heavier than air and will remain at floor level if there is a leak. Basements, crawl spaces, closets and areas below ground level will serve as pockets for accumulation of leaking gas. Before lighting, sniff at floor level. **IF YOU SMELL GAS,** follow applicable instructions on the front cover or on Page 8. **DO NOT OPERATE APPLIANCE UNTIL LEAKAGE IS CORRECTED.**

### ▲ WARNING ▲

**DO NOT USE OPEN FLAME OR ANY KIND OF SPARK TO CHECK FOR LEAKS.**

## TEMPERATURE AND PRESSURE RELIEF VALVE

For protection against excessive pressures and/or temperatures, a temperature and pressure relief valve must be installed in the opening marked, "temperature and pressure relief valve" a design certified by a nationally recognized testing laboratory that maintains periodic inspection of production of listed equipment or materials, as meeting the requirements for Relief Valves and Automatic Gas Shut-Off Devices for Hot Water Supply Systems, Z21.22. Pressure rating of the valve must not exceed the working pressure shown on the data plate of the water heater.

Relief piping must terminate 6 inches above a floor drain or external to the building. Do not thread, cap, or plug the end of this discharge line. Be certain that no contact is made with any live electrical part. Do not connect discharge line directly to drain. (Figure 6).

To prevent bodily injury, hazard to life or damage to property, the relief valve must be allowed to discharge water in the event of excessive temperature or pressure developing in the water heater. The function of the temperature and pressure relief valve is to discharge water in large quantities should circumstances demand. If the discharge pipe is not directed to the drain as shown in Figure 6 or other suitable means, the water flow may cause property damage.

The discharge line:

- (1) Must not be smaller than the pipe size of the relief valve,
- (2) Must not be plugged or blocked,
- (3) Must be of material capable of withstanding 210°F without distortion,
- (4) Must be installed so as to allow complete drainage of both the temperature and pressure relief valve and discharge line,
- (5) Must terminate at an adequate drain,
- (6) Must not have any valve between the relief valve and the heater.

**Failure to install and maintain a new properly listed temperature and pressure relief valve will release the manufacturer from any claims which might result from excessive temperature or water pressure.**

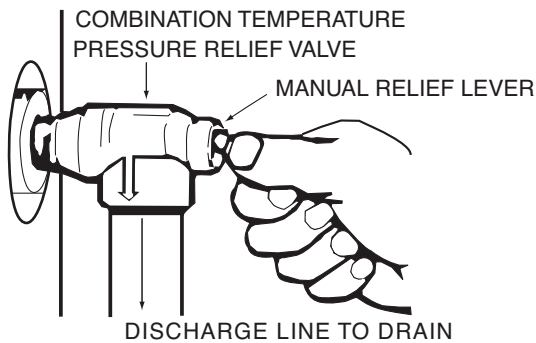

**▲ WARNING ▲**

Do not attempt to operate this water heater with cold water inlet valve closed. Manually operate the temperature and pressure relief valve at least once a year. To prevent water damage, discharge line must terminate at an adequate drain. Standing clear of the outlet (discharge water may be hot), lift and release the lever handle on the temperature and pressure relief valve to make the valve operate freely.

If the heater is installed in a closed system, the temperature and pressure relief valve may drip at times. If the temperature and pressure relief valve discharges a full stream of water, have the system checked. See “Pressure Build-Up in Water System”.

If the temperature and pressure relief valve on the appliance discharges periodically, this may be due to thermal expansion in a closed water supply system (see “Pressure Build-Up in Water System”). Contact the water supplier or local plumbing inspector on how to correct this situation. Do not plug the temperature and pressure relief valve.

## **COMBINATION SPACE HEATING / POTABLE WATER HEATING SYSTEM**

If this water heater is to be used to supply both space heating and domestic potable (drinking) water heating, the instructions listed below must be followed. Be sure to follow manual(s) shipped with air handler system.

Toxic chemicals, such as those used for boiler treatment, shall **NEVER** be introduced into this system.

This unit may **NEVER** be connected to any existing heating system or component(s) previously used with a non-potable water heating appliance.

**DO NOT** use this water heater as a replacement for an existing boiler installation.

**DO NOT** use with piping that has been treated with chromates, boiler seal or other chemicals.

**DO NOT** add boiler treatment or any chemicals to any heat piping, since the piping contains potable water.

**DO NOT** use with ferrous piping. The system should be installed only with new piping that is suitable for potable water, such as copper or polybutylene. **DO NOT** use with PVC piping.

**DO NOT** use any pumps, valves, or fittings that are not completely compatible with potable water piping.

**DO NOT** use valves that may cause excessive restriction to water flow. **USE FULL FLOW BALL OR GATE VALVES ONLY.**

**DO NOT** tamper with the thermostat, gas valve, ignitor control or temperature and pressure relief valve. Tampering with any of these components is **DANGEROUS** and can result in property damage or severe injury. Tampering voids all warranties. Only qualified personnel should service these components.

**DO NOT** use 50/50 solder in potable water lines.

**IF THE SPACE HEATING** system requires water temperature in excess of 120°F, a mixing valve or other means should be installed in the domestic (potable) hot water supply to limit the **RISK OF SCALD DAMAGE**. (See Figure 6)

**SOME JURISDICTIONS** may require a backflow preventer in the incoming cold water line to the water heater. In such cases, the temperature and pressure relief valve on the water heater may weep or relieve due to expansion of the heated water.

A diaphragm-type expansion tank (such as TACO or EXTROL) will normally eliminate this weeping condition. Please read and follow the manufacturer’s instructions for installation of such tanks.

## **WATER PIPING**

Pipes and fittings should be installed in compliance with the installation drawing. Check for dip tube in cold water fitting before connection of hot and cold water lines. If the indoor installation area is subject to freezing temperatures, water piping must be protected. The water heater should be drained if being shut down during freezing temperatures.

Have the installer show you where the cold water inlet valve for the water heater is installed so that you know where and how to shut the water off. It is recommended that such a valve be located in close proximity to the cold water inlet of the water heater. See installation drawing, Figure 6.

Connect the cold water supply to the fitting marked “C” cold, the hot water outlet to the fitting marked “H” hot. Do not apply heat to either of these fittings. If sweat connections are used, sweat tubing to the adaptor before fitting adaptor to the cold and hot water fittings. It is imperative that no heat be applied to the water

heater fittings as they may contain nonmetallic parts. When making these connections, always use a good grade of pipe joint compound and be certain that all fittings are drawn up tight (See Figure 6 for proper installation).

After piping has been installed allow tank to fill with water and check connections for leaks. To insure complete filling of the tank, allow air to exit by opening the nearest hot water faucet until a constant flow of water is obtained.

## ▲ CAUTION

**OPERATING AN EMPTY OR PARTIALLY FILLED WATER HEATER WILL RESULT IN DAMAGE TO THE TANK.**

## SOLAR INSTALLATION

When this appliance is used AS A SOLAR STORAGE HEATER OR AS A BACKUP FOR THE SOLAR SYSTEM, the following warning applies.

### ▲ WARNING ▲

Water supply to this heater must not exceed 180°F. Water temperature in excess of 180°F will cause the high limit control to function or open and shut off gas supply. The high limit control is a single use type that will require the replacement of the thermostat before the burner can operate. If the water supply from the solar system is above 120°F, a tempering valve or temperature limiting valves must be installed in the water supply line to limit the supply temperature to 120°F.

## CHEMICAL VAPOR CORROSION

The water heater should not be installed near an air supply containing halogenated hydrocarbons. Water heater corrosion and component failure can be caused by the heating and breakdown of airborne chemical vapors. Beauty shops, dry cleaning establishments, photo processing labs, storage areas of liquid and powdered bleaches, swimming pool chemicals, spray can propellants, cleaning solvents, refrigerator and air conditioning refrigerants, calcium and sodium chloride, waxes and process chemicals are typical locations and compounds which are potentially corrosive. These materials are corrosive at very low concentration levels with little or not odor to reveal their presence. Products of this sort should not be stored near the water heater. Air which is brought in contact with the water heater should not contain any of these chemicals. If necessary, uncontaminated air should be obtained from remote or outside sources. NOTE: Contaminated air may cause an orange colored flame.

## INSULATION BLANKET

### ▲ CAUTION ▲

Insulation blanket kits which are available for external applications to water heaters are not recommended. However, some governing bodies require their use in new construction of additions, regardless of how efficient the water heater may be.

If an insulation blanket is applied to this heater CAUTION must be exercised not to restrict the proper function of the heater. The manufacturer of this heater will not be liable for

incidents arising or resulting from the use of external insulation blankets. The manufacturer will not be liable for corrosion of parts which may have resulted from the use of such insulation blankets.

(1) The space between the base and the floor on a gas water heater is necessary for proper air flow. This space must be maintained unobstructed. As time passes, the blanket may sag causing an obstruction of this air passage, resulting in an unsafe operating condition.

(2) Do not apply insulation to the top of a gas water heater. This will affect the operation of the draft hood, resulting in an unsafe operating condition.

(3) Do not cover any access panels leading to burner compartments, thermostat(s) control, doors, or temperature & pressure relief valve on the water heater.

(4) Do not cover any labels or instruction material applied to this water heater. These safety labels and instruction material must remain on the water heater and be visible for reference by the user. Do not attempt to remove these labels, as they are a permanent part of this water heater as required by Certification Agencies and/or the Federal Government.

## INSTALLATION CHECK LIST\*

*\*This is presented for ease of reference. It is not comprehensive. All instructions and warnings must be read and adhered to.*

### A. HEATER LOCATION

- Close to area of vent.
- Indoors and protected from freezing temperatures. (Refer to Water Piping Section)
- Proper clearance from combustible surfaces observed and heater not installed directly on carpeted floor.
- Sufficient fresh air supply for proper operation of heater.
- Air supply free of corrosive elements and flammable vapors.
- Provisions made to protect area from water damage.
- Sufficient room to service heater.

### B. WATER SUPPLY (See WATER PIPING)

- Install a cold water inlet valve (Figure 6).
- Heater completely filled with water.
- Water connection tight and free of leaks.

### C. RELIEF VALVE

- Install a new Temperature and Pressure Relief Valve properly and discharge line run to open drain.
- Discharge line protected from freezing (Figure 6).

### D. GAS SUPPLY

- Gas supply same as the type of gas listed on the data plate.
- Gas line equipped with shut-off valve, union and drip leg (Figure 6).
- Approved pipe joint compound used.
- Soap and water solution used to check all connections and fittings for possible gas leaks.

### E. VENTING (Figure 6)

- Draft diverter properly installed.
- Vent connector(s) securely fastened together with screws.
- Vent connector(s) at least 6" from combustible material.
- Flue baffle engaged in slots if provided in flue tube.

## OPERATION

### Safety precautions:

DO turn off heater if it has been subjected to physical damage, flooding, or fire.

DO NOT turn on heater unless it is filled with water.

DO NOT turn on heater if cold water supply inlet valve is closed.

DO NOT attempt to light heater until all lighting instructions are understood and followed. See below and label on heater near thermostat (Figure 6).

DO NOT allow flammable liquids, such as gasoline or paint thinner, to be stored or used near heater.

DO NOT allow combustible materials such as newspaper, rags or mops to accumulate near heater.

### ▲ WARNING ▲

TO AVOID POSSIBLE INJURY, FIRE AND EXPLOSION. READ THESE PRECAUTIONS BEFORE ATTEMPTING TO LIGHT OR RELIGHT THE PILOT. Check the data plate near the gas control valve thermostat for the correct gas. DO NOT USE THIS WATER HEATER WITH ANY GAS OTHER THAN THE ONE LISTED ON THE DATA PLATE (Figure 6). Failure to use the correct gas can cause problems which can result in DEATH, SERIOUS BODILY INJURY, OR PROPERTY DAMAGE. If you have any questions or doubts consult your gas supplier or gas company.

## CONDENSATION

Whenever the heater is filled with cold water or hot water is drawn from a faucet there will be a certain amount of condensation formed while the burner is "ON". Moisture from the products or combustion condenses on the cooler tank surfaces and forms drops of water which may fall onto the burner or other hot surfaces to produce a "sizzling" or "frying" noise. Condensation is normal and should not be confused with a leaking tank.

The water from condensation will be noted at different times of the year in varying quantities. This condensation may spill out of the collector pan onto the floor. Do not confuse this with a leak. Once the water inside of the heater reaches a temperature of 120°F, the condensation will stop. Operating the water heater at the lowest thermostat temperature setting can keep the water heater in the condensation mode. Adjusting the thermostat setting slightly higher will overcome this problem. There is hot water scald potential however if thermostat is set too high.

## NATURAL GAS MODELS

### IF YOU SMELL GAS:

1. Open windows.
2. Get all people out of building.
3. DO NOT light matches. Do not smoke.
4. DO NOT touch electrical switches (on or off).
5. Extinguish any open flames.
6. Shut off gas at manual shut-off valve.

7. Use an outside phone and immediately call the gas company and the fire department. Ask for instructions. Before hanging up, give your name and address.
8. DO NOT go back into the building. If help is coming, wait for it outside of the building.

## L.P.G. (PROPANE, BOTTLED) GAS MODELS

### L.P.G. IS HEAVIER THAN AIR

Should there be a leak in the system, the gas will settle at FLOOR LEVEL. Basements, crawl spaces, skirted areas under mobile homes (even when ventilated), closets and areas below ground level will serve as pockets for the accumulation of gas.

### BEFORE LIGHTING SNIFF AT FLOOR LEVEL IF YOU SMELL GAS, FOLLOW THESE RULES:

1. Open windows.
2. Get all people out of building.
3. DO NOT light matches. Do not smoke.
4. DO NOT touch electrical switches (on or off).
5. Extinguish any open flames.
6. Shut off gas at the L.P. tank outside of the building.
7. Use an outside phone and immediately call the gas company and the fire department. Ask for instructions. Before hanging up, give your name and address.
8. DO NOT go back into the building. If help is coming, wait for it outside of the building.

## OUT OF FUEL

When your L.P. tank runs out of fuel, turn off gas at all gas appliances including gas to pilots. After L.P. tank is refilled, all appliances must be re-lit according to the manufacturer's instructions.

### ▲ WARNING ▲

## HYDROGEN GAS

Hydrogen gas can be produced in a water system that has not been used for a long period of time (generally two weeks or more). **HYDROGEN GAS IS EXTREMELY FLAMMABLE.** To prevent the possibility of injury under these conditions, we recommend the hot water faucet be open for several minutes at the kitchen sink before you use any electrical appliance which is connected to the hot water system. Do not light a cigarette, cigar or pipe. Do not smoke. If hydrogen is present, there will probably be an unusual sound such as air escaping through the faucet, as the water begins to flow. Remember no smoking or open flame near the faucet at the time it is opened.

## EXPOSURE TO WATER

Do not use this appliance if any part has been under water. Immediately call a qualified service technician to inspect the appliance and to replace any part of the control system and any gas control which has been under water.

**FOR YOUR SAFETY READ BEFORE LIGHTING**



**WARNING**

**If you do not follow these instructions exactly, a fire or explosion may result causing property damage, personal injury or loss of life.**

- C. This appliance has a pilot which must be lighted by hand. When lighting the pilot, follow these instructions exactly.
    - If you cannot reach your gas supplier, call the fire department.
  - D. BEFORE LIGHTING smell all around the appliance area for gas. Be sure to smell next to the floor because some gas is heavier than air and will settle on the floor.
- WHAT TO DO IF YOU SMELL GAS**
- Do not try to light any appliance.
  - Do not touch any electrical switch; do not use any phone in your building.
  - Immediately call your gas supplier from a neighbor's phone. Follow the gas supplier's instructions.
- A. Use only your hand to push in or turn the gas control knob. Never use tools. If the knob will not push in or turn by hand, don't try to repair it, call a qualified service technician. Force or attempted repair may result in a fire or explosion.
  - B. Do not use this appliance if any part has been under water. Immediately call a qualified service technician to inspect the appliance and to replace any part of the control system and any gas control which has been under water.

**LIGHTING INSTRUCTIONS**

1. STOP! It is imperative that you read all the safety warnings before lighting the pilot.
2. Remove outer and inner doors.
3. Turn temperature dial counter-clockwise to lowest settings.

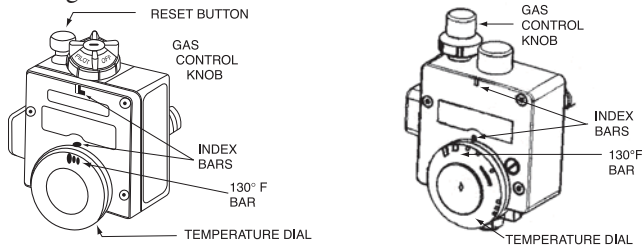

For Gas Natural

For Gas L.P.

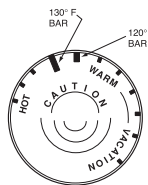

4. Turn gas control knob clockwise to "OFF" position.

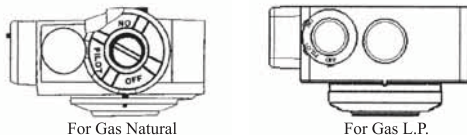

For Gas Natural

For Gas L.P.

5. To clear any gas that may have accumulated wait ten (10) minutes. If you then smell gas, STOP! Follow "B" in the safety warning above on this label. If you don't smell gas go to the next step.
6. Find pilot — Follow the smaller metal tube from the thermostat to the pilot.

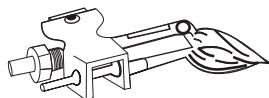

7. Turn gas control knob counter-clockwise to "PILOT" position.

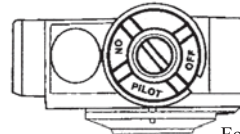

For Gas Natural

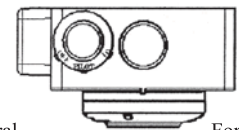

For Gas L.P.

- 8a. **For Gas Natural:** Light match and hold to pilot. While holding lighted match to pilot, depress reset button all the way; hold until pilot lights. Continue to hold the button for one (1) minute after the pilot was lighted. Release the reset button and it will pop back up. Pilot should remain lit. If it goes out, repeat steps 3 through 8.

- 8b. **For Gas LP:** Light match and hold to pilot. While holding lighted match to pilot, depress the gas control knob all the way; hold until pilot lights. Continue to hold the knob for one (1) minute after the pilot was lighted. Release the gas control knob and it will pop back up. Pilot should remain lit. If it goes out, repeat steps 3 through 8.

- If reset button/gas control knob does not pop up when released, stop and immediately shut off gas ahead of control at line valve or tank. Call your service technician or gas supplier.
- If the pilot will not stay lit after several tries, turn the gas cock clockwise to "OFF" position and call your service technician or gas supplier.

9. Replace the inner door.
10. Turn gas control knob counter-clockwise to "ON" position.

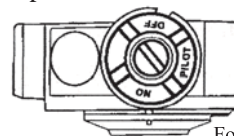

For Gas Natural

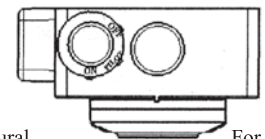

For Gas L.P.

11. Set temperature dial to desired setting.
12. Replace outer door.

**TO TURN OFF GAS TO APPLIANCE**

1. Turn temperature dial counter-clockwise to lowest setting.
2. Turn cock clockwise to "OFF" position.

**FOR YOUR SAFETY READ BEFORE LIGHTING**

**▲ WARNING ▲** If you do not follow these instructions exactly, a fire or explosion may result causing property damage, personal injury or loss of life.

- A. This appliance has a pilot which must be lighted by hand. When lighting the pilot, follow these instructions exactly.
- B. BEFORE LIGHTING smell all around the appliance area for gas. Be sure to smell next to the floor because some gas is heavier than air and will settle on the floor.





**WHAT TO DO IF YOU SMELL GAS**

- Do not try to light any appliance.
- Do not touch any electrical switch; do not use any phone in your building.
- Immediately call your gas supplier from a neighbor's phone. Follow the gas supplier's instructions.

- If you cannot reach your gas supplier, call the fire department.
- C. Use only your hand to push in or turn the gas control knob. Never use tools. If the knob will not push in or move by hand, don't try to repair it, call a qualified service technician. Force or attempted repair may result in a fire or explosion.
- D. Do not use this appliance if any part has been under water. Immediately call a qualified service technician to inspect the appliance and to replace any part of the control system and any gas control which has been under water.

**LIGHTING INSTRUCTIONS**

1. STOP! It is imperative that you read all the safety warnings before lighting the pilot.
2. Remove outer and inner doors.
3. Set the thermostat to lowest setting. (Rotate clockwise).
4. Depress gas control knob slightly and turn clockwise

 to "OFF". If knob is in "ON"  turn clockwise to "PILOT"  then depress knob slightly and turn clockwise  to "OFF".

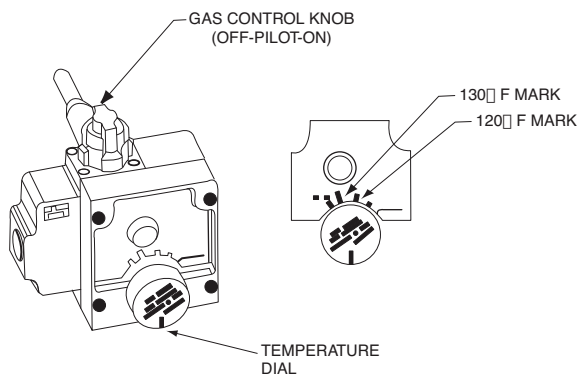

7. Turn gas control knob counter-clockwise  to "PILOT" position.

8. Depress control knob all the way and hold in. IMMEDIATELY light the pilot with a match. Continue to hold the control knob down for about (1) minute after the pilot is lit. Release knob and it will pop back up. Pilot should remain lit, if it goes out, repeat steps 3, 4, 7, and 8.

- If knob does not pop up when released, turn clockwise  to "OFF", stop and immediately call your service technician or gas supplier.

- If the pilot will not stay lit after several tries, turn the gas control knob to "OFF", and call your service technician or gas supplier.



9. Replace the inner door.
10. Turn gas control knob counterclockwise  to "ON".
11. Set temperature dial to desired setting.
12. Replace outer door.

**NOTE:** Knob cannot be turned from "PILOT" to "OFF" unless knob is depressed slightly. Do not use tools or excessive force.

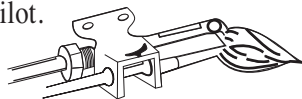
5. To clear any gas that may have accumulated wait ten (10) minutes. If you then smell gas, STOP! Follow "B" in the safety warning above on this label. If you don't smell gas go to the next step.
6. Find pilot — Follow the smaller metal tube from the thermostat to the pilot.



**TO TURN OFF GAS TO APPLIANCE**

1. Set the thermostat to lowest setting.
2. Turn gas control knob clockwise  to "PILOT".
3. Depress gas control knob slightly and turn clockwise  "OFF". Do not use tools or excessive force.

## TEMPERATURE ADJUSTMENT

The temperature selector dial has been adjusted to its lowest setting when shipped from the factory.

For energy-efficient operation of your water heater, the recommended temperature setting is approximately 130°F. Households with small children or invalids may require a 120°F or lower temperature setting to reduce the risk of scald injury. Some states require a lower temperature setting. Check with your gas supplier for local requirements governing the temperature setting. NOTE: The lower the temperature setting the greater the energy efficiency, both to heat water and to maintain its temperature during standby periods. Lower water temperatures also extend the tank life. Remember, no water heating system will provide exact temperatures at all times. Allow a few days of operation at this setting to determine the correct temperature setting consistent with your needs. NOTE: This water heater, when set at the lower temperature setting, is not capable of producing hot water of sufficient temperature for sanitizing purposes.

During winter season or any cold period, you may desire a higher temperature setting to adjust for the colder incoming water. However, this adjustment may cause additional condensation to form on the cooler tank surface. This does not mean the tank is leaking. Refer to Page 8 for explanation of this condition. During the summer months, the warmer incoming water temperatures will benefit the performance of your water heater and reduce the amount of condensation developed.

Condensation does not mean that your tank is leaking. Over 40% of reported tank leaks on installation are proven to be condensation. To avoid unnecessary inconvenience and expense, make sure the tank is leaking before calling a service person.

**CAUTION:** Setting the temperature selector dial higher provides hotter water, which increases the risk of scald injury.

The water heater thermostat is constructed with a built-in shut-off designed to shut off the gas supply to the main Burner and pilot Burner in the event the pilot flame is extinguished for any reason. The thermostat is also equipped with a high temperature limit switch ECO (Energy Cut Off). The Energy Cut Off will shut off all gas supplied to the Burner and pilot Burner in the event the water temperature exceeds 180°F. The Energy Cut Off switch is a single use switch and is not field replaceable. Should the Energy Cut Off function (open), the thermostat must be replaced before the water heater can be placed in operation again.

**VACATION/FREEZING TEMPERATURES** — If the water heater is to remain idle for 30 days or more, or is subject to freezing temperatures while shut off, the water heater and piping should be drained (refer to Page 12), and the drain valve should be left open. Refer to Hydrogen Gas Warning (Page 8).

**GAS PRESSURE** — With the water heater in operation (main burner on), the maximum supply pressure must not exceed the specified value below, and the minimum supply and normal manifold gas pressures are as follows:

Pressure	Supply Pressure		Manifold Pressure
	MAX.	MIN.	
Natural Gas:	10.5" W.C.	5" W.C.	4" W.C. - 4.7" W.C. (see rating plate)
L.P. Gas:	13.0" W.C.	11" W.C.	10" W.C.

Some models have values higher or lower than those noted above. Refer to pressure noted on the label affixed to the front of the water heater. Consult your local gas company or gas supplier if correction is necessary.

## BURNER ADJUSTMENT

There are no adjustments to this water heater (other than water temperature selection). The thermostat (gas control valve) is equipped for total regulation of the main burner and pilot gas pressures.



Only qualified personnel should adjust the pressure regulator.

## BURNER MAINTENANCE

At least once every three months visually check burner and pilot flames and compare with the sketches below. Observation of the gas flame should show the burner flame to be a soft blue with the suggestion of slight yellow tips. A flame of too light of a color may not be a carbonizing flame and should be avoided. If this is suspected, turn the control to the off position, allow combustion chamber to cool, and check the top of the combustion chamber and burner for soot deposits. If soot exists, clean the burner with soap and water. If continued sooting occurs, refer to Trouble Symptoms, Pages 14 and 15.

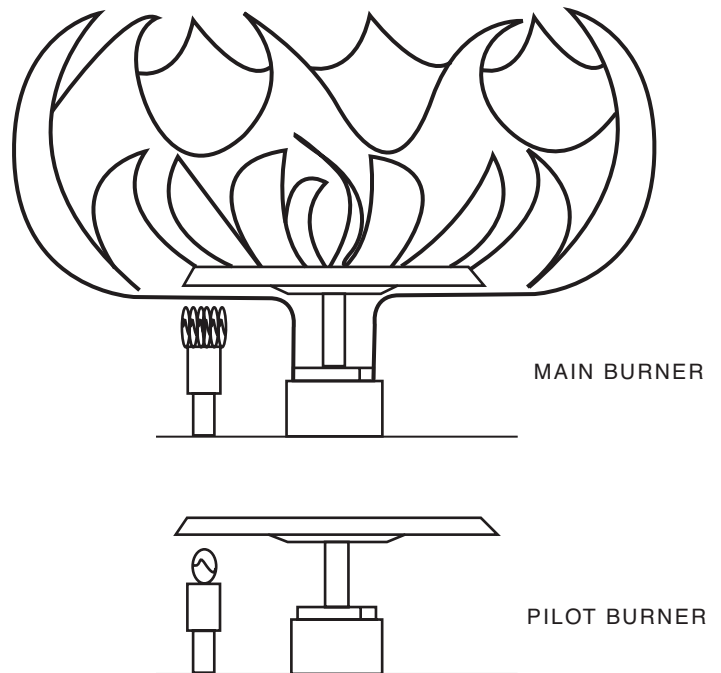

## EMERGENCY SHUT DOWN



Should overheating occur or the gas supply fail to shut off, turn off the manual gas control valve to the appliance and call a qualified service person to check for the cause.

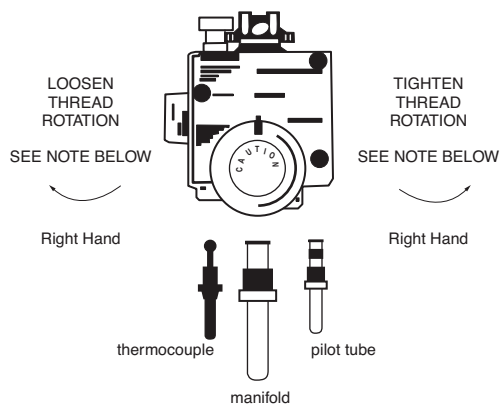

NOTE: L.P. (propane bottled) gas models have reverse (left handed) thread on the manifold.

**▲ WARNING ▲**

DO NOT apply any thread sealant (pipe dope, teflon tape, etc.) to these connections.

### REMOVAL OF THE BURNER ASSEMBLY

For your safety the following procedure should be performed by qualified service personnel or someone familiar with gas appliances, as it involves disconnection of gas piping and leak testing .

1. Turn gas control knob clockwise to "OFF" position. (Page 9 or 10).
2. Open outer and inner doors.
3. Disconnect the thermocouple, pilot tube, and manifold tube at the thermostat (Figure 7). Note that the propane (LPG) manifold has left hand thread rotation.
4. Remove the burner spreader by removing the nuts on top of the spreader.
5. Pull the burner toward the front until the holding bracket slides out of the slot in the bottom pan. If the burner is dirty or clogged it can be cleaned with soap and water.

### REPLACING THE BURNER ASSEMBLY

1. Insert the burner assembly into the opening in the bottom pan and slide toward the rear so that the burner holding bracket slides into the slot in the bottom pan. Reinsert the spreader on to the burner post and replace the two nuts.
2. The manifold tube will now line up to the thermostat connection.
3. Reconnect the manifold tube and pilot tube. Do not cross thread these fittings (Figure 7) . Note that the propane (LPG) manifold has left hand thread rotation.
4. Reconnect the thermocouple. The thermocouple nut should be started and turned all the way in by hand. An additional one-quarter turn with a 3/8" open end wrench will be sufficient to set the lockwasher (Figure 7).

**CAUTION: OVERTIGHTENING MAY DAMAGE THE THERMOCOUPLE OR THERMOSTAT.**

5. Follow Lighting Instructions to relight water heater.
6. Check for gas leaks with soap and water solution (soap suds) or liquid detergent. Bubble forming indicates a leak. **FIX ALL LEAKS IMMEDIATELY.**

**▲ WARNING ▲**

**DO NOT USE OPEN FLAME OR ANY KIND OF SPARK TO CHECK FOR LEAKS.**

## THERMOCOUPLE AND/OR PILOT REPLACEMENT

1. Remove burner assembly. (See "REMOVAL OF BURNER ASSEMBLY" section.)
2. Grasp the thermocouple line and moderately pull the thermocouple from the pilot burner assembly. NOTE: If for any reason the thermocouple will not disengage from the pilot bracket assembly, replace the complete pilot assembly, follow steps 4 and 5, otherwise go to next step.
3. Push replacement thermocouple through hole in pilot bracket until it snaps in place. The end of a properly installed thermocouple should extend approximately 1/4 inch past the tip of the pilot assembly (Go to step 6).
4. Remove No. 8-32 screw holding pilot assembly and pilot shield (if provided) to main burner (Figure 8, Page 16).
5. Re-install replacement pilot assembly to main burner making sure that pilot shield (if provided) is in the right location. (Figure 8, Page 16).
6. Replace burner assembly (See "REPLACING THE BURNER ASSEMBLY" section).

### DRAINING AND FLUSHING INTERIOR OF TANK

The water heater should be drained if being shut down during freezing temperatures. Also periodic draining and cleaning of sediment from the tank may be necessary.

1. "TURN OFF GAS TO APPLIANCE." (Figure 6)
2. Close the cold water inlet valve to the heater (Figure 6).
3. Open a nearby hot water faucet.
4. Open the heater drain valve. (Figure 6).

**▲ WARNING ▲**

**THIS WATER CAN BE HOT.**

5. If the heater is going to be shut down and drained for an extended period, the drain valve should be left open. Refer to "Hydrogen Gas" warning, Page 8.
6. To start heater again, read paragraph "Operation" and "LIGHTING INSTRUCTIONS".

### VENTING SYSTEM INSPECTION

Check the draft hood relief opening (Figure 6) using a match flame after 15 minutes of operation. Pass the match flame around the relief opening of the draft hood. A steady flame drawn into the opening indicates proper draft. If the flame flutters or is blown out this would indicate spillage and corrective action must be made to the vent. (Figure 6).

At least every 3 months a visual inspection should be made of the venting system. You should look for:

- Obstructions which cause improper venting.
- Damage or deterioration which could cause improper venting or leakage of combustion products.

### TAMPERING

Tampering with the thermostat, gas valve, pilot, burner, or temperature and pressure relief valve is DANGEROUS and voids all warranties. Only qualified personnel should service these components.

## ANODE

In each water heater there is installed at least one anode rod (see Parts section) for protection of the tank. Certain water conditions will cause a reaction between this rod and the water. This is defined as smelly water and removal of the rod will void any warranties stated or implied. The parts list includes a special anode that can be ordered if odor and/or discoloration occur. However, this rod is only good to a certain point, after which, we can only suggest that a water conditioning company be contacted to supply filtration equipment.

## WATER HEATER SOUNDS

1. Possible noises due to expansion and contraction of some metal parts during periods of heat-up and cool-down do not represent harmful or dangerous conditions.
2. Sediment build-up in the tank bottom will create varying amounts of noise, and may cause premature tank failure. Tank bottom may need cleaning. (See "DRAINING AND FLUSHING INTERIOR OF TANK").
3. Condensation causes sizzling and popping within the burner area during heating and cooling periods and should be considered normal. See "CONDENSATION" Page 8.

### SERVICE MUST BE PERFORMED BY A QUALIFIED INSTALLER, SERVICE AGENCY OR GAS SUPPLIER

FOLLOWING IS A LIST OF THE MOST COMMON COMPLAINTS RELATED TO THE USE OF WATER HEATERS. MANY COMPLAINTS ARE DUE TO ITEMS NOT DIRECTLY RELATED TO THE WATER HEATER. **DO NOT ATTEMPT TO SERVICE THE WATER HEATER OR PERFORM OTHER RECOMMENDATIONS ON THIS LIST UNLESS YOU ARE TRAINED AND QUALIFIED TO DO SO.**

## COMMON COMPLAINTS

SYMPTOM	POSSIBLE CAUSES(S)	CORRECTIVE ACTION
Burner will not ignite	<ol style="list-style-type: none"> <li>1. No gas</li> <li>2. Dirt in gas lines</li> <li>3. Pilot line clogged</li> <li>4. Main burner line clogged</li> <li>5. Defect thermocouple</li> <li>6. Defective thermostat</li> <li>7. Thermostat set too low</li> </ol>	<ol style="list-style-type: none"> <li>1. Check with utility</li> <li>2. Notify utility-install dirt trap in gas lines</li> <li>3. Clean-check for source of trouble &amp; correct</li> <li>4. Clean-check for source of trouble &amp; correct</li> <li>5. Replace with new thermocouple</li> <li>6. Replace with new thermostat</li> <li>7. Turn temperature knob to desired temperature</li> </ol>
Burner flame floats Lifts off ports	<ol style="list-style-type: none"> <li>1. High gas pressure</li> <li>2. Orifice too large</li> <li>3. Flue clogged</li> <li>4. Heater installed in confined area</li> <li>5. Cold drafts</li> </ol>	<ol style="list-style-type: none"> <li>1. Check with utility</li> <li>2. Replace with correct orifice</li> <li>3. Clean flue and burner-check for a source of trouble &amp; correct</li> <li>4. Provide ventilation by use of louvers in wall or duct</li> <li>5. Check source &amp; correct</li> </ol>
Burner flame yellow-lazy	<ol style="list-style-type: none"> <li>1. Insufficient secondary air</li> <li>2. Low gas pressure</li> <li>3. Flue clogged</li> <li>4. Main burner line clogged</li> <li>5. Heater installed in confined area</li> <li>6. Check main burner orifice for obstruction</li> </ol>	<ol style="list-style-type: none"> <li>1. Provide ventilation to heater</li> <li>2. Check with utility</li> <li>3. Clean-check for source of trouble &amp; correct</li> <li>4. Clean-check for source of trouble &amp; correct</li> <li>5. Provide ventilation by use of louvers in wall or duct</li> <li>6. Clean or replace orifice</li> </ol>
Burner flame too high	<ol style="list-style-type: none"> <li>1. Insufficient secondary air</li> <li>2. Orificetoo large</li> </ol>	<ol style="list-style-type: none"> <li>1. Provide ventilation to heater</li> <li>2. Replace with correct orifice</li> </ol>

## COMMON COMPLAINTS (continued)

SYMPTOM	POSSIBLE CAUSES(S)	CORRECTIVE ACTION
Flame burns at orifice	<ol style="list-style-type: none"> <li>1. Low gas pressure</li> <li>2. Defective thermostat</li> </ol>	<ol style="list-style-type: none"> <li>1. Check with utility</li> <li>2. Replace with new thermostat</li> </ol>
Pilot will not remain lit	<ol style="list-style-type: none"> <li>1. Low gas pressure</li> <li>2. No gas</li> <li>3. Dirt in gas lines</li> <li>4. Pilot line or orifice clogged</li> <li>5. Thermocouple connection loose</li> <li>6. Defective thermocouple</li> <li>7. Cold drafts</li> <li>8. Thermostat ECO switch open</li> </ol>	<ol style="list-style-type: none"> <li>1. Check with utility</li> <li>2. Check with utility</li> <li>3. Notify utility-install dirt trap in gas lines</li> <li>4. Clean-check for source of trouble &amp; correct</li> <li>5. Tighten with fingers-then take 1/4 turn with wrench</li> <li>6. Replace with new thermocouple</li> <li>7. Check source and correct</li> <li>8. Replace thermostat</li> </ol>
High operating costs	<ol style="list-style-type: none"> <li>1. Improper calibration</li> <li>2. Thermostat set too high</li> <li>3. Sediment or lime in tank</li> <li>4. Heater too small for job</li> <li>5. Wrong piping connections</li> <li>6. Leaking faucets</li> <li>7. Gas leaks</li> <li>8. Wasted hot water</li> <li>9. Long runs of exposed piping</li> <li>10. Hot water piping in outside wall</li> <li>11. Nofluebaffle</li> </ol>	<ol style="list-style-type: none"> <li>1. Replace thermostat</li> <li>2. Turn temperature Dial to desired temperature</li> <li>3. Drain-check to see if water treatment is necessary</li> <li>4. Install adequate heater</li> <li>4. Correct piping-dip tube must be in cold inlet</li> <li>6. Repair faucets</li> <li>7. Check with utility-repair at once</li> <li>8. Advise users</li> <li>9. Insulate</li> <li>10. Insulate</li> <li>11. Install flue baffle</li> </ol>
Insufficient hot water	<ol style="list-style-type: none"> <li>1. Low gas pressure</li> <li>2. Orifice too small</li> <li>3. Improper calibration</li> <li>4. Thermostat set too low</li> <li>5. Sediment or lime in tank</li> <li>6. Heater too small for job</li> <li>7. Wrong piping connections</li> <li>8. Leaking faucets</li> <li>9. Wasted hot water</li> <li>10. Long runs of exposed piping</li> <li>11. Hot water piping in outside wall</li> </ol>	<ol style="list-style-type: none"> <li>1. Check with utility</li> <li>2. Replace with correct orifice</li> <li>3. Replace thermostat</li> <li>4. Turn temperature Dial to desired temperature</li> <li>5. Drain-check to see if water treatment is necessary</li> <li>6. Install adequate heater</li> <li>7. Correct piping-dip tube must be in cold inlet</li> <li>8. Repair faucets</li> <li>9. Advise users</li> <li>10. Insulate</li> <li>11. Insulate</li> </ol>
Slow hot water recovery	<ol style="list-style-type: none"> <li>1. Insufficient secondary air</li> <li>2. Low gas pressure</li> <li>3. Orifice too small</li> <li>4. Improper calibration</li> <li>5. Thermostat set too low</li> <li>6. Heater too small for job</li> <li>7. Wrong piping connections</li> <li>8. Wasted hot water</li> </ol>	<ol style="list-style-type: none"> <li>1. Provide ventilation to heater. Check flueway &amp; flue baffle assembly for obstructions.</li> <li>2. Check with utility</li> <li>3. Replace with correct orifice</li> <li>4. Replace thermostat</li> <li>5. Turn temperature Dial to desired setting</li> <li>6. Install adequate heater</li> <li>7. Correct piping-dip tube must be in cold inlet</li> <li>8. Advise users</li> </ol>
Drip from relief valve	<ol style="list-style-type: none"> <li>1. Excessive water pressure</li> <li>2. Heater stacking</li> <li>3. Closed water system</li> </ol>	<ol style="list-style-type: none"> <li>1. Use pressure reducing valve and pressure relief valve</li> <li>2. Lower thermostat setting</li> <li>3. See Page 1, "Pressure Build-up in Water System"</li> </ol>

## COMMON COMPLAINTS (continued)

SYMPTOM	POSSIBLE CAUSES(S)	CORRECTIVE ACTION
Thermostat fails to shut off	<ol style="list-style-type: none"> <li>1. Defective thermostat</li> <li>2. Improper calibration</li> </ol>	<ol style="list-style-type: none"> <li>1. Replace with new thermostat (control value)</li> <li>2. Replace control valve</li> </ol>
Condensation	<ol style="list-style-type: none"> <li>1. Temperature setting too low</li> </ol>	<ol style="list-style-type: none"> <li>1. See page 8 and 11</li> </ol>
Combustion odors Smoking and carbon formation (sooting)	<ol style="list-style-type: none"> <li>1. Insufficient secondary air</li> <li>2. Flue clogged</li> <li>3. Heater installed in confined area</li> </ol>	<ol style="list-style-type: none"> <li>1. Provide ventilation to heater</li> <li>2. Clean-check for source of trouble &amp; correct. Check flueway &amp; flue baffle &amp; burner</li> <li>3. Provide ventilation by use of louvers in walls or ducts</li> </ol>
formation (sooting)	<ol style="list-style-type: none"> <li>1. Insufficient secondary air</li> <li>2. Low gas pressure</li> <li>3. Orifice too large</li> <li>4. Flue clogged</li> <li>5. Defective thermostat</li> <li>6. Heater installed in confined area</li> <li>7. Burner flame yellow-lazy</li> </ol>	<ol style="list-style-type: none"> <li>1. Provide ventilation to heater. Check flueway, &amp; flue baffle assembly &amp; burner</li> <li>2. Check with utility</li> <li>3. Replace with correct orifice</li> <li>4. Clean-check for source of trouble &amp; correct</li> <li>5. Replace with new thermostat (control valve)</li> <li>6. Provide ventilation by use of louvers in wall or duct</li> <li>7. See section "Burner Flame Yellow-Lazy" Page 13</li> </ol>
Pilot flame too small	<ol style="list-style-type: none"> <li>1. Low gas pressure</li> <li>2. Pilot line or orifice clogged</li> <li>3. Wrong pilot burner</li> </ol>	<ol style="list-style-type: none"> <li>1. Check with utility</li> <li>2. Clean-check for source of trouble &amp; correct</li> <li>3. Replace</li> </ol>
Pilot flame too large	<ol style="list-style-type: none"> <li>1. Wrong pilot burner</li> </ol>	<ol style="list-style-type: none"> <li>1. Replace</li> </ol>
Smelly water	<ol style="list-style-type: none"> <li>1. Sulfides in the water</li> </ol>	<ol style="list-style-type: none"> <li>1. Replace the anode with a special anode</li> </ol>

# REPAIR PARTS ILLUSTRATION

PARTS REPLACEMENT MUST BE PERFORMED BY A QUALIFIED INSTALLER, SERVICE AGENCY OR GAS

ITEM NO.	PARTS DESCRIPTION	
1	DRAFTHOOD	
2	REDUCER RING (SOME MODELS)	
3	BAFFLE	
4	COLD WATER DIP TUBE	
5	HEAT TRAP (SOME MODELS)	
6	ANODE ROD (NOT SHOWN)	▲
7	TEMPERATURE & PRESSURE RELIEF VALVE	■
8	Drain VALVE	
9	THERMOSTAT	★
	<small>PROPANE GAS THERMOSTAT WILL BE MARKED FOR LP GAS ONLY</small>	
10	MAN I FOLD	
11	ORIFICE	★
12	MAIN BURNER	★
13	BURNER SPREADER	★
14	THERMOCOUPLE	
15	PILOT TUBE	
16	PILOTASSEMBLY	★
17	CLEANOUT PLATE (SOME MODELS)	
18	CLEANOUT O RING (SOME MODELS)	
19	JACKET CLEANOUT COVER (SOME MODELS)	
20	INNER DOOR (SOME MODELS)	
21	OUTER DOOR	

## LEGEND

- ▲ Special anode rod (see page 13)
- Temperature & Pressure Relief Valve is required, but may not be factory installed.
- ★ It is imperative the replacement main burner, main burner orifice, manifold, pilot burner, and the thermostat be ordered for the proper gas type. Natural gas thermostat will be marked with a 3.5 pressure setting. Propane gas thermostat will be marked "For L.P. Gas Only."

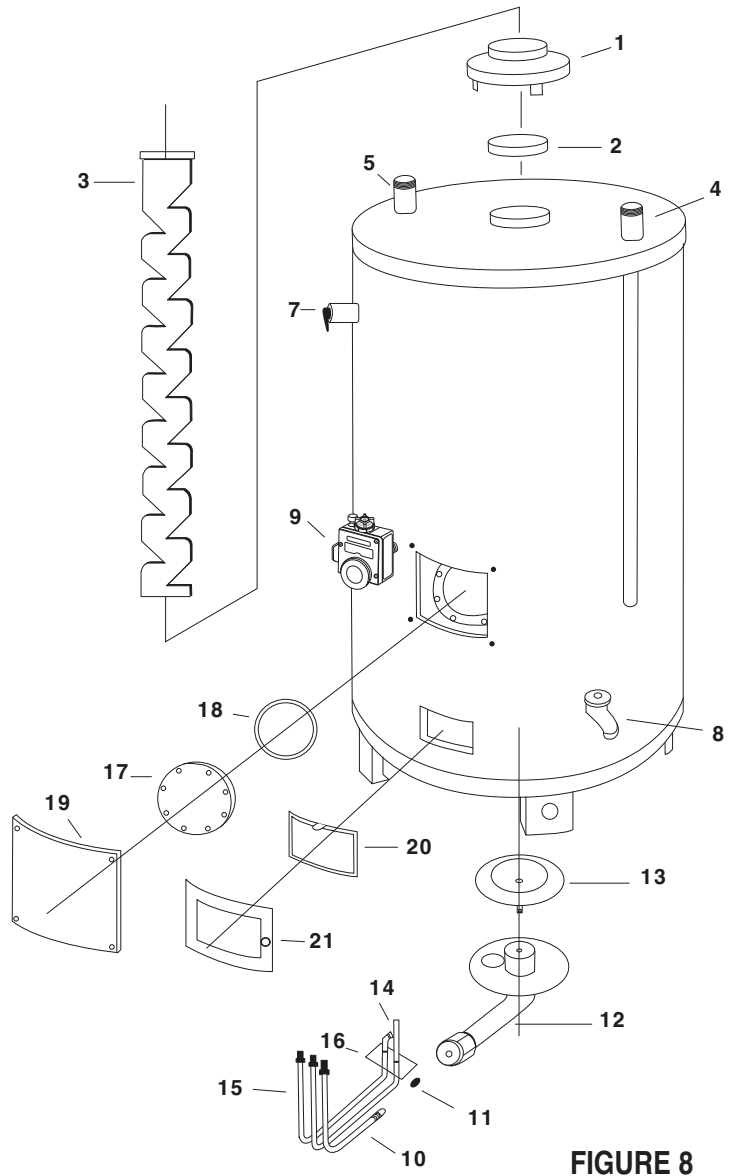

FIGURE 8

WHEN ORDERING REPAIR PARTS ALWAYS GIVE THE FOLLOWING INFORMATION: (1) MODEL AND SERIAL NUMBER, (2) TYPE OF GAS, (3) ITEM NUMBER, (4) PARTS DESCRIPTION.

THE ABOVE PARTS MAY BE ORDERED THROUGH YOUR PLUMBER, A LOCAL SUPPLY COMPANY, OR DIRECT FROM THE FACTORY. PARTS WILL BE SHIPPED AND BILLED AT PREVAILING PRICES AT THE TIME OF SHIPMENT. REFER TO YOUR WARRANTY FOR FACTORY ADDRESS.